

Data sheet | Item number: 857-357

Relay module; Nominal input voltage: 115 V AC/DC; 1 changeover contact;
Limiting continuous current: 6 A; Yellow status indicator; Module width: 6
mm; 2,50 mm²; gray

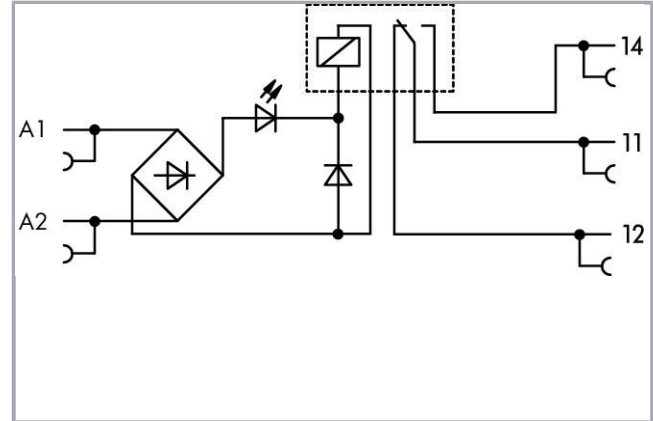

RoHS Compliant

BOMcheck.net

Color: ■

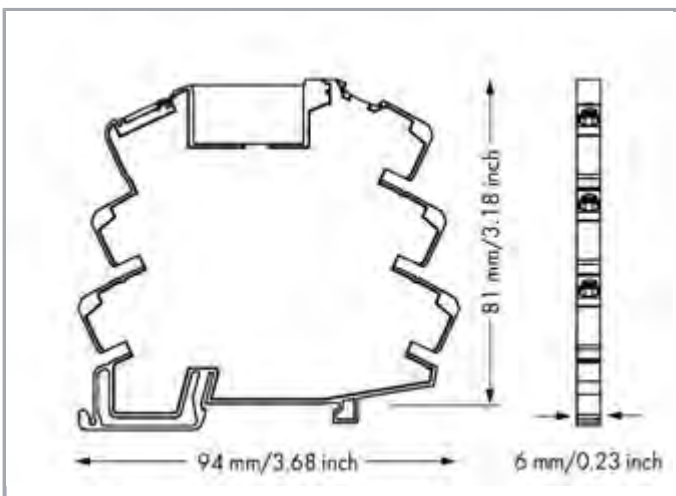

Subject to changes. Please also observe the further product documentation!

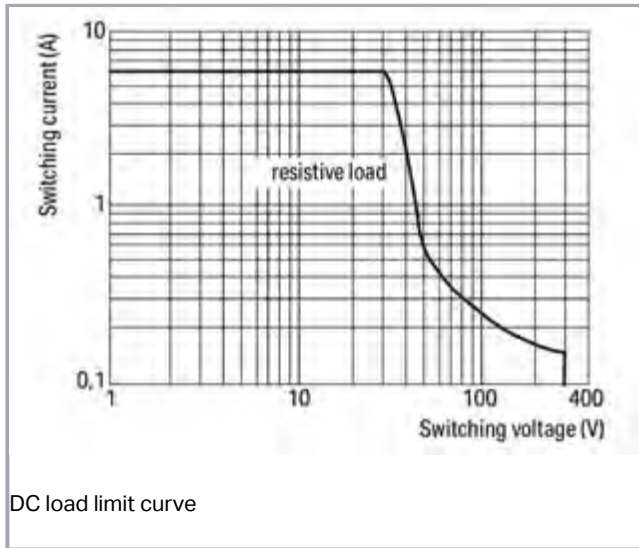

Item description

Note:

To protect the relay coils and contacts, inductive loads must be dampened with an effective protection circuit.

Data

Technical Data

Control circuit

Nominal input voltage U_N	AC/DC 115 V
Input voltage range	$\pm 20\%$
Nominal input current at U_N	4 mA

Load circuit:

Number of changeover/switchover contacts	1
Contact material (relay)	AgSnO ₂
Limiting continuous current	6 A
Inrush current (resistive) (max.)	(AC) 20 A / 0.02 s
Switching voltage (max.)	AC 250 V
Switching power (resistive) (max.)	AC 1500 VA; DC (see load limit curve)
Switching capacity	AC-15: 3 A / AC 250 V; DC-13: 2 A / DC 24 V
Recommended minimum load	10 V / 10 mA; 24 V / 1 mA

Subject to changes. Please also observe the further product documentation!



Pull-in time (typ.)	15 ms
Drop-out time (typ.)	25 ms
Bounce time (typ.)	3.5 ms
Electrical life (NO; resistive load; 23 °C)	50 x 10 ³ switching operations
Mechanical life	5 x 10 ⁶ switching operations
Switching frequency with/without load (max.)	6 min ⁻¹ / 180 min ⁻¹

Signaling

Status indicator	Yellow LED
------------------	------------

Safety and protection:

Rated voltage	250 V
Rated surge voltage	4 kV
Pollution degree	2
Dielectric strength, control/load circuit (AC, 1 min)	4 kVrms
Dielectric strength, open contact (AC, 1 min)	1 kVrms
Protection type	IP20

Connection data

Connection technology	Push-in CAGE CLAMP®
Solid conductor	0.34 ... 2.5 mm ² / 22 ... 14 AWG
Fine-stranded conductor	0.34 ... 2.5 mm ² / 22 ... 14 AWG
Strip length	9 ... 10 mm / 0.35 ... 0.39 inch

Geometrical Data

Width	6 mm / 0.236 inch
Height from upper-edge of DIN-rail	81 mm / 3.189 inch
Depth	94 mm / 3.701 inch

Mechanical data

Mounting type	DIN-35 rail
---------------	-------------

Material Data

Color	gray
Fire load	0.011 MJ

Subject to changes. Please also observe the further product documentation!

Weight	32.2g
--------	-------

Environmental Requirements

Surrounding air temperature (operation at U_N)	-40 ... 60 °C
Surrounding air temperature (storage)	-40 ... 70 °C
Processing temperature	-25 ... +50 °C

Standards and specifications

Standards/specifications	EN 61010-2-201; EN 61810-1; EN 61373; UL 508; ATEX; IEC Ex
--------------------------	--

Elementary relay



WAGO Basic Relay	857-155
------------------	---------

Commercial data

Product Group	6 (Interface Electronics)
Packaging type	BOX
Country of origin	CN
GTIN	4045454694029
Customs tariff number	85364900990

Approvals / Certificates

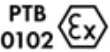
Ex-Approvals

Logo	Approval	Additional Approval Text	Certificate name
	ATEX DEKRA EXAM GmbH	EN 60079-0	BVS_14_ATEX_E_091_X
	IECEX DEKRA EXAM GmbH	IEC 60079-0	IECEX_BVS_14.0079_X
	UL UL International Germany GmbH (HAZARDOUS LOCATIONS)	ANSI/ISA 12.12.01	E198726 Sec.4

UL-Approvals











Certificate

Subject to changes. Please also observe the further product documentation!

Logo	Approval	Additional Approval Text	name
	UL UL International Netherlands B.V. (ORDINARY LOCATIONS)	UL 508	E175199 Sec.4

Compatible products

Jumper

	Item no.: 281-482 Jumper; insulated; gray
	Item no.: 859-402 Jumper; for jumper slot; 2-way; insulated; light gray
	Item no.: 859-402/000-005 Jumper; for jumper slot; 2-way; insulated; red
	Item no.: 859-402/000-006 Jumper; for jumper slot; 2-way; insulated; blue
	Item no.: 859-402/000-029 Jumper; for jumper slot; 2-way; insulated; yellow
	Item no.: 859-403 Jumper; for jumper slot; 3-way; insulated; light gray
	Item no.: 859-403/000-005 Jumper; for jumper slot; 3-way; insulated; red
	Item no.: 859-403/000-006 Jumper; for jumper slot; 3-way; insulated; blue
	Item no.: 859-403/000-029 Jumper; for jumper slot; 3-way; insulated; yellow
	Item no.: 859-404 Jumper; for jumper slot; 4-way; insulated; light gray

Subject to changes. Please also observe the further product documentation!



Item no.: 859-404/000-005
Jumper; for jumper slot; 4-way; insulated; red



Item no.: 859-404/000-006
Jumper; for jumper slot; 4-way; insulated; blue



Item no.: 859-404/000-029
Jumper; for jumper slot; 4-way; insulated; yellow



Item no.: 859-405
Jumper; for jumper slot; 5-way; insulated; light gray



Item no.: 859-405/000-005
Jumper; for jumper slot; 5-way; insulated; red



Item no.: 859-405/000-006
Jumper; for jumper slot; 5-way; insulated; blue



Item no.: 859-405/000-029
Jumper; for jumper slot; 5-way; insulated; yellow



Item no.: 859-406
Jumper; for jumper slot; 6-way; insulated; light gray



Item no.: 859-406/000-005
Jumper; for jumper slot; 6-way; insulated; red



Item no.: 859-406/000-006
Jumper; for jumper slot; 6-way; insulated; blue



Item no.: 859-406/000-029
Jumper; for jumper slot; 6-way; insulated; signal yellow



Item no.: 859-407
Jumper; for jumper slot; 7-way; insulated; light gray



Item no.: 859-407/000-005
Jumper; for jumper slot; 7-way; insulated; red



Item no.: 859-407/000-006
Jumper; for jumper slot; 7-way; insulated; blue

Subject to changes. Please also observe the further product documentation!



Item no.: 859-407/000-029
Jumper; for jumper slot; 7-way; insulated; yellow



Item no.: 859-408
Jumper; for jumper slot; 8-way; insulated; light gray



Item no.: 859-408/000-005
Jumper; for jumper slot; 8-way; insulated; red



Item no.: 859-408/000-006
Jumper; for jumper slot; 8-way; insulated; blue



Item no.: 859-408/000-029
Jumper; for jumper slot; 8-way; insulated; yellow



Item no.: 859-409
Jumper; for jumper slot; 9-way; insulated; light gray



Item no.: 859-409/000-005
Jumper; for jumper slot; 9-way; insulated; red



Item no.: 859-409/000-006
Jumper; for jumper slot; 9-way; insulated; blue



Item no.: 859-409/000-029
Jumper; for jumper slot; 9-way; insulated; yellow



Item no.: 859-410
Jumper; for jumper slot; 10-way; insulated; light gray



Item no.: 859-410/000-005
Jumper; for jumper slot; 10-way; insulated; red



Item no.: 859-410/000-006
Jumper; for jumper slot; 10-way; insulated; blue



Item no.: 859-410/000-029
Jumper; for jumper slot; 10-way; insulated; yellow

ferrule



Item no.: 216-241
Ferrule; Sleeve for 0.5 mm² / 20 AWG; insulated; electro-tin plated; electrolytic copper; gastight crimped; acc. to DIN 46228, Part 4/09.90; white

Subject to changes. Please also observe the further product documentation!



Item no.: 216-242

Ferrule; Sleeve for 0.75 mm² / 18 AWG; insulated; electro-tin plated; electrolytic copper; gastight crimped; acc. to DIN 46228, Part 4/09.90; gray



Item no.: 216-243

Ferrule; Sleeve for 1 mm² / AWG 18; insulated; electro-tin plated; electrolytic copper; gastight crimped; acc. to DIN 46228, Part 4/09.90; red



Item no.: 216-244

Ferrule; Sleeve for 1.5 mm² / AWG 16; insulated; electro-tin plated; electrolytic copper; gastight crimped; acc. to DIN 46228, Part 4/09.90; black

General accessories



Item no.: 209-184

Protection cover; transparent



Item no.: 857-155

Basic relay; Nominal input voltage: 60 VDC; 1 changeover contact; Limiting continuous current: 6 A; Module width: 5 mm; Module height: 15 mm

tools



Item no.: 210-720

Operating tool; Blade: 3.5 x 0.5 mm; with a partially insulated shaft

Marking accessories



Item no.: 2009-110

Marking strips; on reel; not stretchable; plain; snap-on type; white



Item no.: 2009-115

WMB-Inline; for Smart Printer; 1500 pieces on roll; stretchable 5 - 5.2 mm; plain; snap-on type; white



Item no.: 2009-115/000-002

WMB-Inline; for Smart Printer; 1500 pieces on roll; stretchable 5 - 5.2 mm; plain; snap-on type; yellow



Item no.: 2009-115/000-006

WMB-Inline; for Smart Printer; 1500 pieces on roll; stretchable 5 - 5.2 mm; plain; snap-on type; blue



Item no.: 2009-115/000-007

WMB-Inline; for Smart Printer; 1500 pieces on roll; stretchable 5 - 5.2 mm; plain; snap-on type; gray



Item no.: 2009-115/000-012

WMB-Inline; for Smart Printer; 1500 pieces on roll; stretchable 5 - 5.2 mm; plain; snap-on type; orange



Item no.: 2009-115/000-017

WMB-Inline; for Smart Printer; 1500 pieces on roll; stretchable 5 - 5.2 mm; plain; snap-on type; light green



Item no.: 2009-115/000-023

WMB-Inline; for Smart Printer; 1500 pieces on roll; stretchable 5 - 5.2 mm; plain; snap-on type; green

Subject to changes. Please also observe the further product documentation!



Item no.: 2009-115/000-024

WMB-Inline; for Smart Printer; 1500 pieces on roll; stretchable 5 - 5.2 mm; plain; snap-on type; violet



Item no.: 209-128

Adaptor; gray



Item no.: 209-183

Marker card; white



Item no.: 210-110

Fiber-tip pen



Item no.: 249-105

Group marker carrier; gray



Item no.: 793-501

WMB marking card; as card; not stretchable; plain; snap-on type; white



Item no.: 793-501/000-002

WMB marking card; as card; not stretchable; plain; snap-on type; yellow



Item no.: 793-501/000-005

WMB marking card; as card; not stretchable; plain; snap-on type; red



Item no.: 793-501/000-006

WMB marking card; as card; not stretchable; plain; snap-on type; blue



Item no.: 793-501/000-007

WMB marking card; as card; not stretchable; plain; snap-on type; gray



Item no.: 793-501/000-012

WMB marking card; as card; not stretchable; plain; snap-on type; orange



Item no.: 793-501/000-017

WMB marking card; as card; not stretchable; plain; snap-on type; light green



Item no.: 793-501/000-023

WMB marking card; as card; not stretchable; plain; snap-on type; green



Item no.: 793-501/000-024

WMB marking card; as card; not stretchable; plain; snap-on type; violet



Item no.: 793-502

WMB marking card; as card; MARKED; 1 ... 10 (10x); not stretchable; Horizontal marking; snap-on type; white

Subject to changes. Please also observe the further product documentation!



Item no.: 793-502/000-002

WMB marking card; as card; MARKED; 1 ... 10 (10x); not stretchable; Horizontal marking; snap-on type; yellow



Item no.: 793-502/000-005

WMB marking card; as card; MARKED; 1 ... 10 (10x); not stretchable; Horizontal marking; snap-on type; red



Item no.: 793-502/000-006

WMB marking card; as card; MARKED; 1 ... 10 (10x); not stretchable; Horizontal marking; snap-on type; blue



Item no.: 793-502/000-007

WMB marking card; as card; MARKED; 1 ... 10 (10x); not stretchable; Horizontal marking; snap-on type; gray



Item no.: 793-502/000-012

WMB marking card; as card; MARKED; 1 ... 10 (10x); not stretchable; Horizontal marking; snap-on type; orange



Item no.: 793-502/000-017

WMB marking card; as card; MARKED; 1 ... 10 (10x); not stretchable; Horizontal marking; snap-on type; light green



Item no.: 793-502/000-023

WMB marking card; as card; MARKED; 1 ... 10 (10x); not stretchable; Horizontal marking; snap-on type; green



Item no.: 793-502/000-024

WMB marking card; as card; MARKED; 1 ... 10 (10x); not stretchable; Horizontal marking; snap-on type; violet



Item no.: 793-503

WMB marking card; as card; MARKED; 11 ... 20 (10x); not stretchable; Horizontal marking; snap-on type; white



Item no.: 793-503/000-002

WMB marking card; as card; MARKED; 11 ... 20 (10x); not stretchable; Horizontal marking; snap-on type; yellow



Item no.: 793-503/000-005

WMB marking card; as card; MARKED; 11 ... 20 (10x); not stretchable; Horizontal marking; snap-on type; red



Item no.: 793-503/000-006

WMB marking card; as card; MARKED; 11 ... 20 (10x); not stretchable; Horizontal marking; snap-on type; blue



Item no.: 793-503/000-007

WMB marking card; as card; MARKED; 11 ... 20 (10x); not stretchable; Horizontal marking; snap-on type; gray

Item no.: 793-503/000-012

WMB marking card; as card; MARKED; 11 ... 20 (10x); not stretchable; Horizontal marking; snap-on type;

Subject to changes. Please also observe the further product documentation!



orange



Item no.: 793-503/000-017

WMB marking card; as card; MARKED; 11 ... 20 (10x); not stretchable; Horizontal marking; snap-on type; light green



Item no.: 793-503/000-023

WMB marking card; as card; MARKED; 11 ... 20 (10x); not stretchable; Horizontal marking; snap-on type; green



Item no.: 793-503/000-024

WMB marking card; as card; MARKED; 11 ... 20 (10x); not stretchable; Horizontal marking; snap-on type; violet



Item no.: 793-504

WMB marking card; as card; MARKED; 21 ... 30 (10x); not stretchable; Horizontal marking; snap-on type; white



Item no.: 793-504/000-002

WMB marking card; as card; MARKED; 21 ... 30 (10x); not stretchable; Horizontal marking; snap-on type; yellow



Item no.: 793-504/000-005

WMB marking card; as card; MARKED; 21 ... 30 (10x); not stretchable; Horizontal marking; snap-on type; red



Item no.: 793-504/000-006

WMB marking card; as card; MARKED; 21 ... 30 (10x); not stretchable; Horizontal marking; snap-on type; blue



Item no.: 793-504/000-012

WMB marking card; as card; MARKED; 21 ... 30 (10x); not stretchable; Horizontal marking; snap-on type; orange



Item no.: 793-504/000-017

WMB marking card; as card; MARKED; 21 ... 30 (10x); not stretchable; Horizontal marking; snap-on type; light green



Item no.: 793-504/000-023

WMB marking card; as card; MARKED; 21 ... 30 (10x); not stretchable; Horizontal marking; snap-on type; green



Item no.: 793-505

WMB marking card; as card; MARKED; 31 ... 40 (10x); not stretchable; Horizontal marking; snap-on type; white



Item no.: 793-505/000-005

WMB marking card; as card; MARKED; 31 ... 40 (10x); not stretchable; Horizontal marking; snap-on type; red

Item no.: 793-505/000-006

WMB marking card; as card; MARKED; 31 ... 40 (10x); not stretchable; Horizontal marking; snap-on type;

Subject to changes. Please also observe the further product documentation!



blue



Item no.: 793-505/000-007

WMB marking card; as card; MARKED; 31 ... 40 (10x); not stretchable; Horizontal marking; snap-on type; gray



Item no.: 793-505/000-012

WMB marking card; as card; MARKED; 31 ... 40 (10x); not stretchable; Horizontal marking; snap-on type; orange



Item no.: 793-506

WMB marking card; as card; MARKED; 41 ... 50 (10x); not stretchable; Horizontal marking; snap-on type; white



Item no.: 793-506/000-005

WMB marking card; as card; MARKED; 41 ... 50 (10x); not stretchable; Horizontal marking; snap-on type; red



Item no.: 793-506/000-006

WMB marking card; as card; MARKED; 41 ... 50 (10x); not stretchable; Horizontal marking; snap-on type; blue



Item no.: 793-506/000-012

WMB marking card; as card; MARKED; 41 ... 50 (10x); not stretchable; Horizontal marking; snap-on type; orange



Item no.: 793-506/000-017

WMB marking card; as card; MARKED; 41 ... 50 (10x); not stretchable; Horizontal marking; snap-on type; light green



Item no.: 793-5501

WMB marking card; as card; for terminal block width 5 - 17.5 mm; stretchable 5 - 5.2 mm; plain; snap-on type; white



Item no.: 793-5501/000-002

WMB marking card; as card; for terminal block width 5 - 17.5 mm; stretchable 5 - 5.2 mm; plain; snap-on type; yellow



Item no.: 793-5501/000-005

WMB marking card; as card; for terminal block width 5 - 17.5 mm; stretchable 5 - 5.2 mm; plain; snap-on type; red



Item no.: 793-5501/000-006

WMB marking card; as card; for terminal block width 5 - 17.5 mm; stretchable 5 - 5.2 mm; plain; snap-on type; blue



Item no.: 793-5501/000-007

WMB marking card; as card; for terminal block width 5 - 17.5 mm; stretchable 5 - 5.2 mm; plain; snap-on type; gray

Item no.: 793-5501/000-012

WMB marking card; as card; for terminal block width 5 - 17.5 mm; stretchable 5 - 5.2 mm; plain; snap-on

Subject to changes. Please also observe the further product documentation!



type; orange



Item no.: 793-5501/000-014

WMB marking card; as card; for terminal block width 5 - 17.5 mm; stretchable 5 - 5.2 mm; plain; snap-on type; brown



Item no.: 793-5501/000-017

WMB marking card; as card; for terminal block width 5 - 17.5 mm; stretchable 5 - 5.2 mm; plain; snap-on type; green



Item no.: 793-5501/000-023

WMB marking card; as card; for terminal block width 5 - 17.5 mm; stretchable 5 - 5.2 mm; plain; snap-on type; light green



Item no.: 793-5501/000-024

WMB marking card; as card; for terminal block width 5 - 17.5 mm; stretchable 5 - 5.2 mm; plain; snap-on type; violet



Item no.: 793-566

WMB marking card; as card; MARKED; 1 ... 50 (2x); not stretchable; Horizontal marking; snap-on type; white



Item no.: 793-566/000-002

WMB marking card; as card; MARKED; 1 ... 50 (2x); not stretchable; Horizontal marking; snap-on type; yellow



Item no.: 793-566/000-005

WMB marking card; as card; MARKED; 1 ... 50 (2x); not stretchable; Horizontal marking; snap-on type; red



Item no.: 793-566/000-006

WMB marking card; as card; MARKED; 1 ... 50 (2x); not stretchable; Horizontal marking; snap-on type; blue



Item no.: 793-566/000-007

WMB marking card; as card; MARKED; 1 ... 50 (2x); not stretchable; Horizontal marking; snap-on type; gray



Item no.: 793-566/000-012

WMB marking card; as card; MARKED; 1 ... 50 (2x); not stretchable; Horizontal marking; snap-on type; orange



Item no.: 793-566/000-017

WMB marking card; as card; MARKED; 1 ... 50 (2x); not stretchable; Horizontal marking; snap-on type; light green



Item no.: 793-566/000-023

WMB marking card; as card; MARKED; 1 ... 50 (2x); not stretchable; Horizontal marking; snap-on type; green

Item no.: 793-566/000-024

Subject to changes. Please also observe the further product documentation!



WMB marking card; as card; MARKED; 1 ... 50 (2x); not stretchable; Horizontal marking; snap-on type; violet

Downloads

Documentation

Instruction Leaflet

Relaisbaustein mit steckbarem Kleinschaltrelais
1 Wechsler (1u) Eingangsnennspannung AC/DC 115 V

Elektromechanical and Solid-State Relays/Optocouplers

V 1.4.0
Oct 15, 2019

CAD/CAE-Data

CAD data

2D/3D Models 857-357

CAE data

EPLAN Data Portal 857-357

WSCAD Universe 857-357

ZUKEN Portal 857-357

Installation Notes

Conductor termination

Subject to changes. Please also observe the further product documentation!

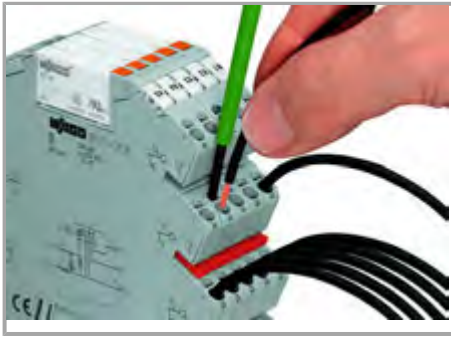

Connection of conductor

Commoning



Easy commoning using adjacent jumpers

Marking



Marking using WMB Multi markers

Installation

Subject to changes. Please also observe the further product documentation!



Operation of the relay ejector

Subject to changes. Please also observe the further product documentation!
